

BANGI

Design Altherr Désile Park



Rectangular table 140 cod. BNGTL140

Steel frame
Steel top

6 persons

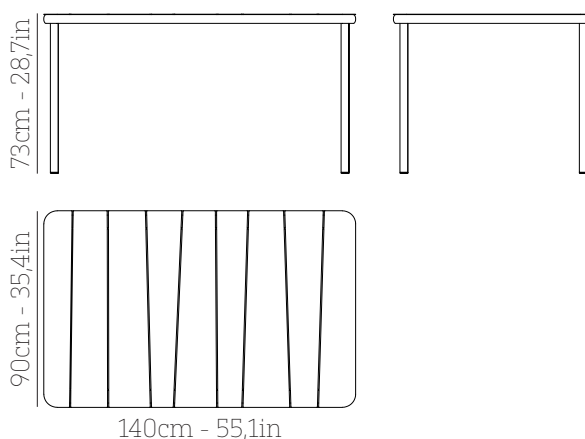

* 2D and 3D files are available at www.babel.it

Anticorrosive primer®

Application of a coat of protective anticorrosive epoxy resin-based paint.

Powder coating

60-80µm polyester powder coating for outdoor resistance and high protection.

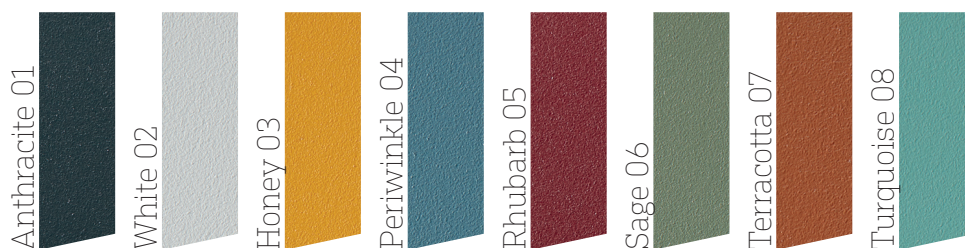

Maintenance

BABEL D products are treated to guarantee a long service life while preserving their functional and aesthetic qualities. BABEL D products will last longer if you take care of them by cleaning them with a soft cloth and water or neutral detergents every three to six months, depending on the

environmental and climatic conditions.

Do not use abrasive detergents and brushes. Be careful using BABEL D products in marine environments with high humidity or near swimming pools, especially in closed environments if chlorine is used as a disinfectant.